

# LAP

- Laparoscopy Instruments
- Mini Laparsocopy Instruments
- Detachable Operating Forceps
- Bipolar Coagulation Forceps
- Spring Grasping Forceps
- Needle Holding Forceps
- Electric Coagulation Instruments
- Suction and Irrigation Tube
- Trocars
- Automatic Suction and Rinsing Apparatus
- Single Hole - Umbilical Laparoscopy Instruments
- Thoracoscopy Instruments
- Small Incision Instruments

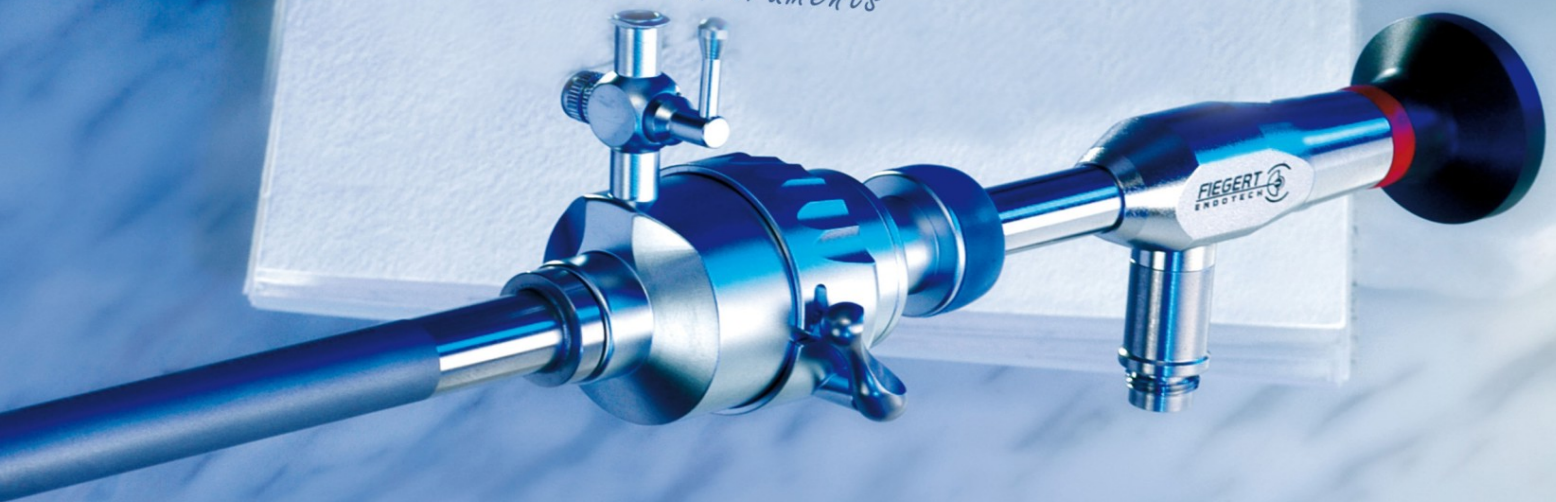

**SURGERY**

**LAPAROSCOPY INSTRUMENTS**

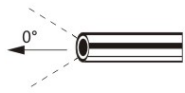

E0004.1 0°  $\Phi$ 5×302mm Autoclave  
E0021 0°  $\Phi$ 10×330mm Autoclave

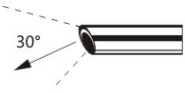

E0005.1 30°  $\Phi$ 5×302mm  
134° C2bar Autoclave  
E0022 30°  $\Phi$ 10×330mm  
134° C2bar Autoclave

1. Connecting to FIEGERT light guide cable  
Connecting to OLYMPUS light guide cable  
Connecting to STORZ light guide cable
2. Connecting to WOLF light guide cable
3. Connecting to ACMI, STRYKER light guide cable



Laparoscope

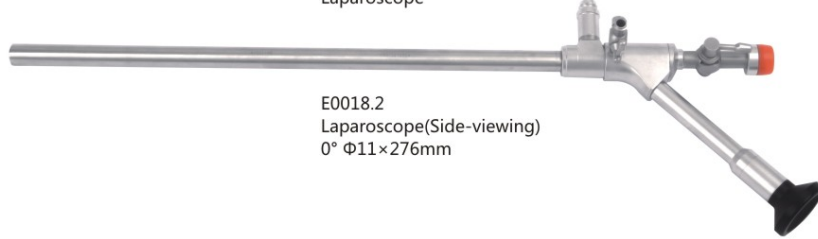

E0018.2  
Laparoscope(Side-viewing)  
0°  $\Phi$ 11×276mm



$\Phi$ 10×330mm Clip applicator



E2001.1 Single action  
E2001.5 Detachable, single action



E2001.2 Double action



E2001.3 Right angle



E2001.7  
For Johnson clip



E2001.8  
For Plastic clip  
E2001.11  $\Phi$ 10×330mm



E2001.9  
For Johnson plastic clip



E2001.10  
For weck clip

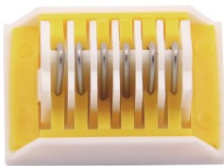

E5001 4#Clip



E5001.1 2#Clip



E5002 3#Clip

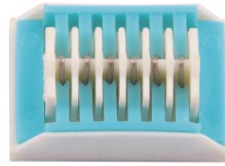

E5003 5#clip

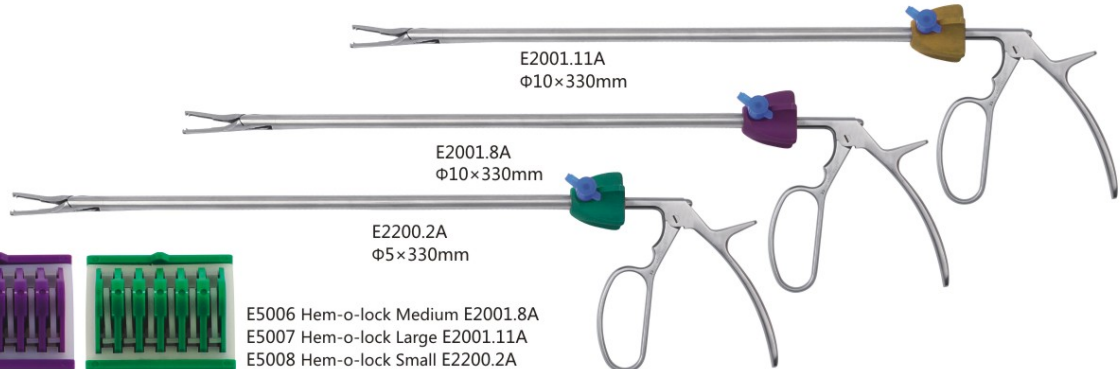

E2001.11A  
 $\Phi$ 10×330mm

E2001.8A  
 $\Phi$ 10×330mm

E2200.2A  
 $\Phi$ 5×330mm



Large



Medium



Small

E5006 Hem-o-lock Medium E2001.8A  
E5007 Hem-o-lock Large E2001.11A  
E5008 Hem-o-lock Small E2200.2A



**SURGERY**

*Laparoscopy instruments*



Absorbable clip  
E5010 12mm  
E5011 8mm



E2001.6  
Biological clip applicator  
Φ10×330mm

*Detachable operating forceps*

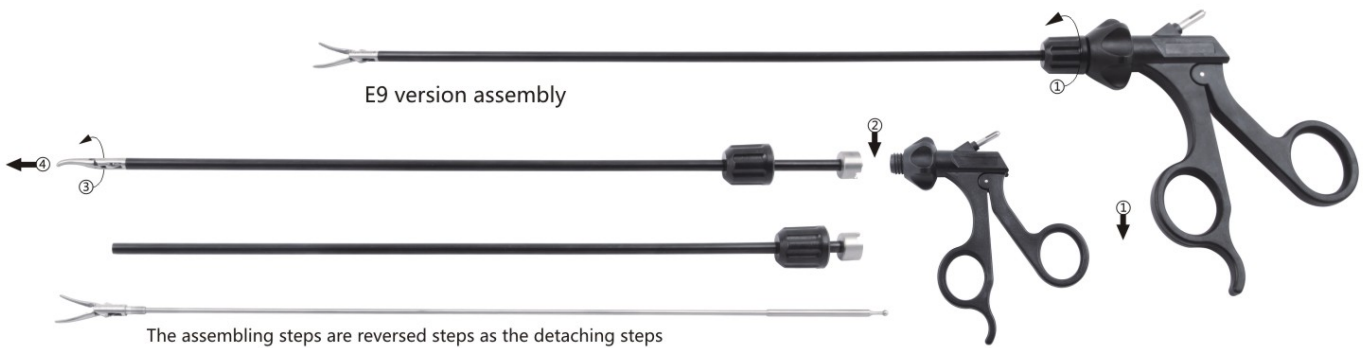

E9 version assembly

The assembling steps are reversed steps as the detaching steps

*Flexible and rotatable forceps*

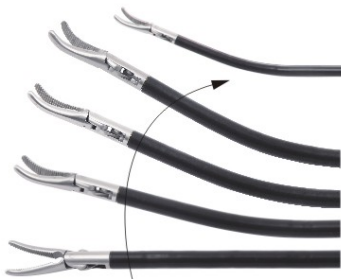

Schematic diagram



E9005.1KW  
Dissecting forceps, straight



E9005.2KW  
Dissecting forceps, curved



E9005.8KW  
Fixation grasping forceps, serrated



E9005.9KW  
Fixation grasping forceps, loop



E9006.1KW  
Scissor, straight



E9006.3KW 15mm  
Scissor, curved



E9007.9KW 21mm  
Gallbladder grasping forceps



E9007.10KW 21mm  
Grasping forceps, greeve tooth

## Φ5×330mm Laparoscopy instruments

PPSU Handle<sup>①</sup>  
(134°C 2bar)  
Autoclavable



PPSU Handle  
(134°C 2bar)  
Autoclavable

For this handle  
items start with  
E2 (005.1) and so on



E9005.1  
Dissecting forceps, straight  
(Head length 17mm)



E9005.6  
Dissecting forceps, 90° angled  
(Head length 17mm)  
E9035 (Head length 13mm)



E9005.17  
Dissecting forceps for hemostasis



E9006.4  
Scissor, hook, Single action  
(Head length 9mm)



E9005.2  
Dissecting forceps, curved  
(Head length 17mm)  
E9005.2C Head length 18mm  
E9005.2D Head length 20mm



E9005.7  
Fixation grasping forceps, crocodile  
(Head length 17mm)



E9005.18  
Dissecting forceps for renal  
artery free



E9006.10  
Scissor, curved, head with ball  
(Head length 16mm)



E9005.3  
Dissecting forceps, 30° angled  
(Head length 17mm)



E9005.8  
Fixation grasping forceps, serrated  
(Head length 13mm)



E9006.1  
Scissor, straight  
(Head length 13mm)



E9007  
Grasping forceps  
(Head length 14mm)



E9005.4  
Dissecting forceps, 45° angled  
(Head length 17mm)



E9005.9  
Fixation grasping forceps, loop  
(Head length 17mm)



E9006.2  
Scissor, straight, Single action  
(Head length 13mm)



E9007.1  
Blunt grasping forceps  
(Head length 17mm)



E9005.5  
Dissecting forceps, 70° angled  
(Head length 17mm)



E9005.15  
Grasping forceps



E9006.3  
Scissor, curved  
(Head length 15mm)



E9007.4  
Atraumatic grasping forceps  
Single action (Head length 18mm)



**SURGERY**

*Φ5×330mm Laparoscopy instruments*



E9007.5  
Atraumatic grasping forceps  
(Head length 15mm)



E9007.12  
Grasping forceps Single action  
(Head length 32mm)



E9007.20  
Grasping forceps Single action  
(Head length 15mm)



E9007.27  
Grasping forceps



E9007.6  
Grasping forceps, rat toothed  
Single action  
(Head length 15mm)



E9007.13  
Grasping forceps, flask style  
(Head length 25mm)



E9007.21  
Grasping forceps  
(Head length 22mm)



E9007.31  
Grasping forceps, round spoon head  
(Head length 22mm)



E9007.7  
Grasping forceps, double spoon  
(Head length 10mm)



E9007.14  
Grasping forceps, clasping  
(Head length 30mm)



E9007.22  
Appendix grasping forceps  
(Head length 21mm)



E9007.32  
Single tooth grasping forceps  
(Head length 21mm)



E9007.8  
Gallbladder grasping forceps rough  
toothed(Head length 18mm)



E9007.16  
Grasping forceps 2×3 teeth, Single action  
(Head length 30mm)



E9007.23  
Atraumatic grasping forceps  
(Head length 30 mm)



E9007.33  
Grasping forceps



E9007.9  
Gallbladder grasping forceps  
toothed(Head length 21mm)



E9007.17  
Grasping forceps 3×4 teeth, Single action  
(Head length 30mm)



E9007.24  
Grasping forceps, blunt-pointed  
With nail(Head length 14mm)



E9007.34  
Grasping forceps



E9007.10  
Grasping forceps, greeve tooth  
(Head length 21mm)



E9007.18  
Atraumatic grasping forceps, Allie  
(Head length 30mm)



E9007.25  
Grasping forceps, heavy type  
(Head length 18mm)



E9007.34A  
Stomach grasping forceps



E9007.11  
Grasping forceps  
(Head length 21mm)



E9007.19  
Grasping forceps, Parker  
(Head length 13mm)



E9007.26  
Grasping forceps 2×3teeth  
(Head length 18mm)



E9007.34B  
Grasping forceps

## Φ5×330mm Laparoscopy instruments



E9007.35  
Anastomosis traction forceps



E9007.43  
Grasping forceps



E9007.91  
Gallbladder grasping forceps



E9022D  
Intestinal forceps



E9007.35C  
Anastomosis traction forceps



E9007.44  
Grasping forceps



E9020  
Tying forceps, type A  
(Head length 17mm)



E9024  
Grasping forceps, bullet head  
(Head length 15mm)



E9007.36  
Grasping forceps  
(Head length 19mm)



E9007.45  
Grasping forceps, reticulate



E9020.1  
Tying forceps, type B  
(Head length 17mm)



E9024.1  
Grasping forceps, round bullet head  
with spoon (Head length 12mm)



E9007.39  
Grasping forceps, tough tooth, hollow  
(Head length 21mm)



E9007.46  
Grasping forceps



E9021  
Small biopsy forceps, single action  
(Head length 15mm)



E9025  
Grasping forceps, crocodile head  
(Head length 15mm)



E9007.41  
Grasping forceps



E9007.47  
Grasping forceps



E9022  
Intestinal forceps  
(Head length 40mm)



E9034  
Grasping forceps, snake  
(Head length 15mm)



E9007.42  
Grasping forceps



E9007.48  
Grasping forceps



E9022E  
Grasping forceps



E9018A6  
Lung forceps  
(Head length 32mm)



E9007.49  
Salpinx Grasping forceps



E9022C  
Intestinal forceps



$\Phi 10 \times 330\text{mm}$  Large laparoscopy instruments



E2002  
Large grasping forceps, Single action  
(Head length 27mm)



E2004.2  
Large dissecting forceps, insulated  
(Head length 22mm)



E2004.6  
Large dissecting forceps  
(Head length 23mm)



E2003  
Lithotomy forceps, Single action  
(Head length 30mm)



E2004.2A  
Large dissecting forceps, insulated  
(90°, Head length 30mm)



E2004.7  
Grasping forceps, duck mouth  
(Head length 30mm)



E2004  
Large dissecting forceps, insulated  
(Head length 22mm)



E2004.4  
Large dissecting forceps  
(Head length 30mm)



E2004.8  
Grasping forceps, atraumatic  
Head length 36mm



E2004.1  
Large dissecting forceps, insulated  
(Head length 22mm)



E2004.5  
Grasping forceps(Head length 60mm)



E2004.9  
Large dissecting forceps  
(Head length 40mm)

**SURGERY**

$\Phi 10 \times 330\text{mm}$  Large laparoscopy instruments



E2004.11  
Grasping forceps, atraumatic  
Head length 30mm



E2006.8  
Large curved scissors  
(Head length 28mm)



Grasping forceps  
E2007.52 E9007.53  
E2007.54



E2004.12 90°  
Large dissecting forceps



E2006.11  
Large straight scissors



E2007.9C  
Gallbladder grasping forceps  
toothed(Head length 35mm)



E2004.14  
Lithotomy forceps, double action



E2007.34C  
Stomach Grasping forceps



E2008.65  
Grasping forceps, Bulldog



Large dissecting forceps  
E2005.410  
E2005.410A 45°



E2007.34D  
Stomach Grasping forceps



E2008.66  
Hemostatic clips  
(Head length 45mm/65mm)



E2006  
Large straight Scissor  
(Head length 18mm)



E2007.37  
Grasping forceps, single tooth



E2018  
Lung forceps  
(Head length 43mm)



E2006.6  
Large curved scissors  
blade with teeth, single action  
(Head length 24mm)



E2007.40  
Grasping forceps for hemostasis



E2022.1  
Intestinal forceps  
(Head length 68mm)



## SURGERY

### Bipolar coagulating forceps

Work with M1020.1 High frequency cord

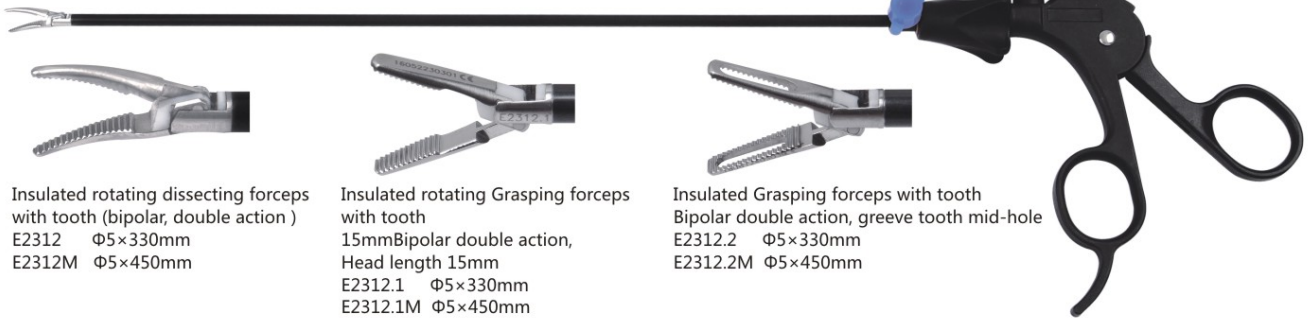

Insulated rotating dissecting forceps with tooth (bipolar, double action)  
E2312  $\Phi 5 \times 330\text{mm}$   
E2312M  $\Phi 5 \times 450\text{mm}$

Insulated rotating Grasping forceps with tooth  
15mm Bipolar double action,  
Head length 15mm  
E2312.1  $\Phi 5 \times 330\text{mm}$   
E2312.1M  $\Phi 5 \times 450\text{mm}$

Insulated Grasping forceps with tooth  
Bipolar double action, greeve tooth mid-hole  
E2312.2  $\Phi 5 \times 330\text{mm}$   
E2312.2M  $\Phi 5 \times 450\text{mm}$

Work with M1006 High frequency cord



Insulated grasping forceps with tooth (bipolar)  
E2316  $\Phi 5 \times 330\text{mm}$   
E2316.1  $\Phi 5 \times 450\text{mm}$

### Needle holder (Head length 12mm)

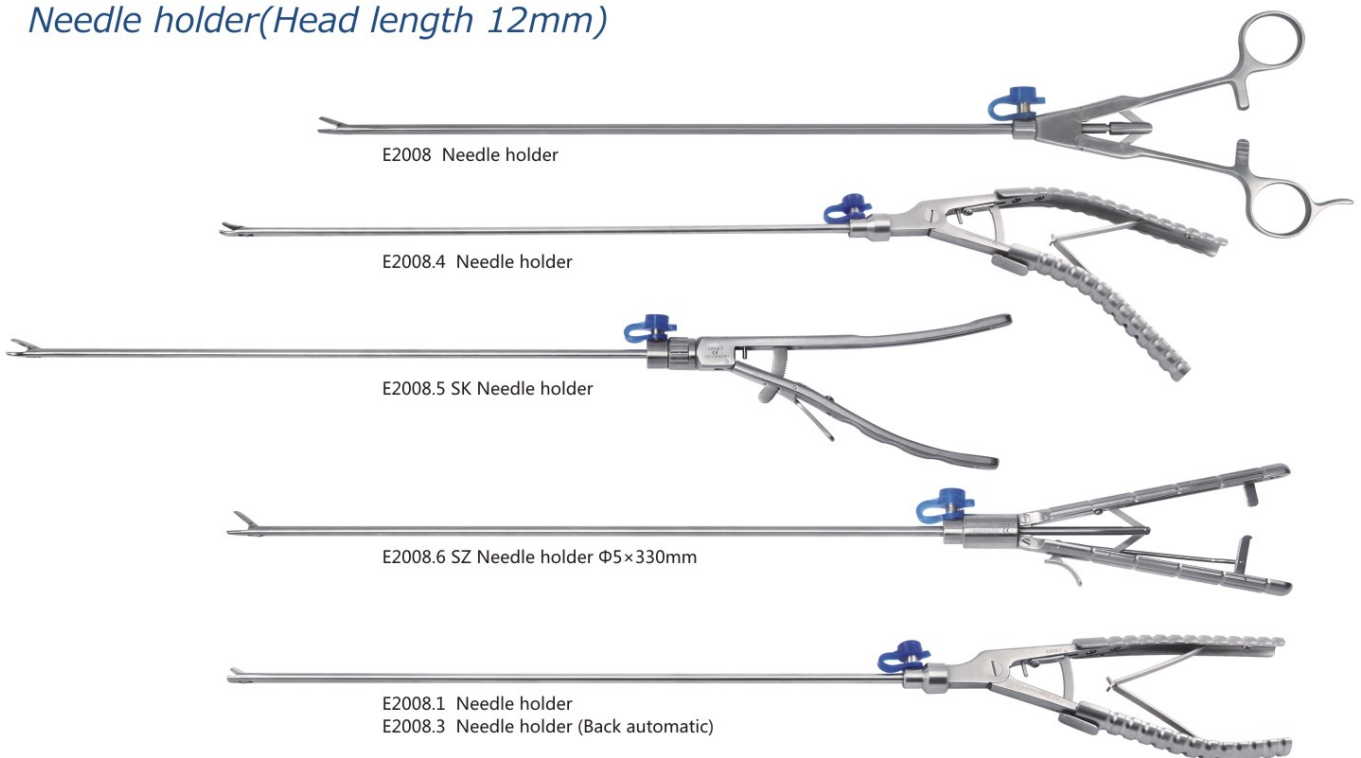

E2008 Needle holder

E2008.4 Needle holder

E2008.5 SK Needle holder

E2008.6 SZ Needle holder  $\Phi 5 \times 330\text{mm}$

E2008.1 Needle holder  
E2008.3 Needle holder (Back automatic)



Straight



Left curved



Right curved



Back automatic

**SURGERY**

$\Phi 3 \times 330/250/220\text{mm}$  Laparoscopy instruments



*Laparoscopy instruments*

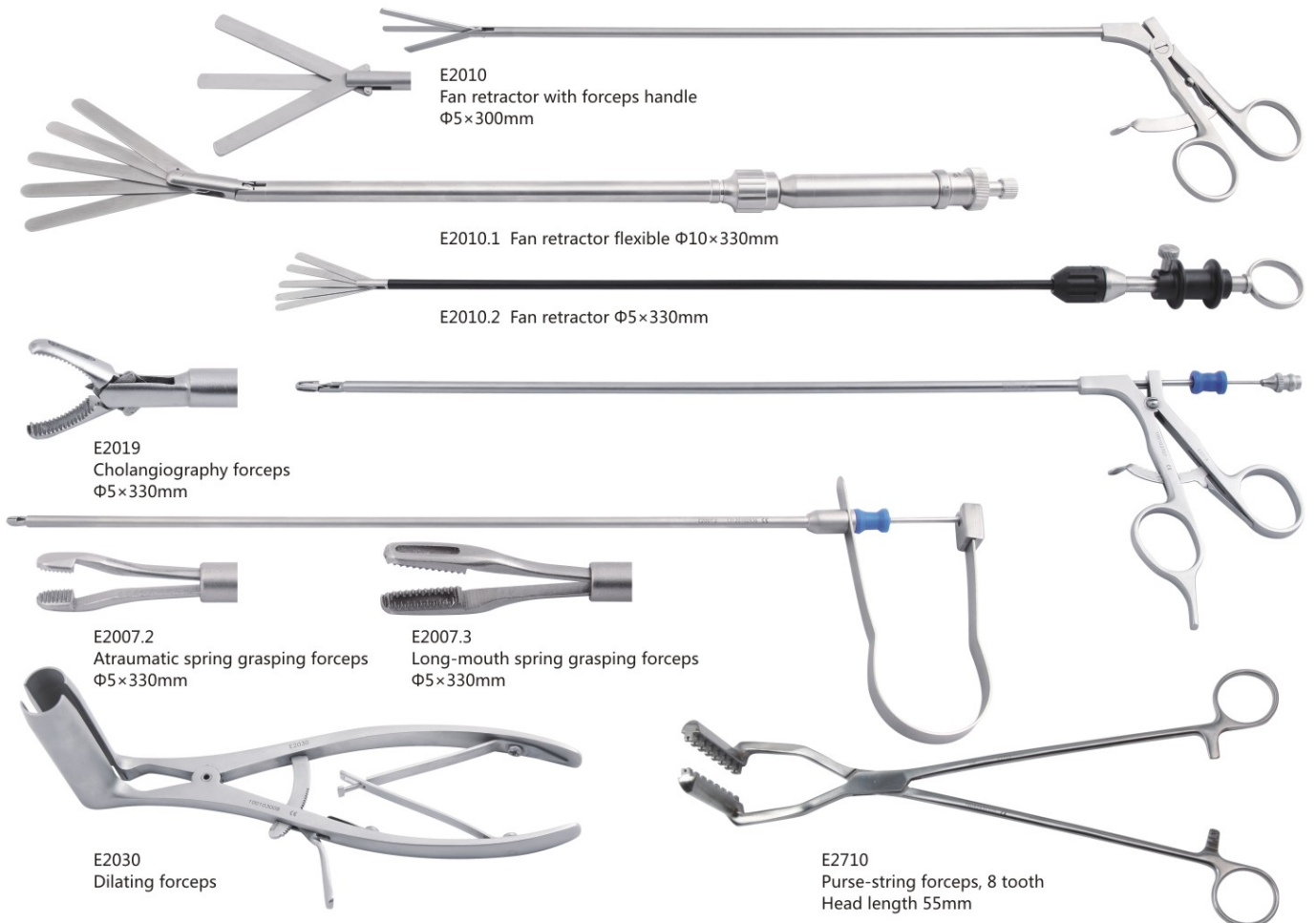



**SURGERY**

*Laparoscopy instruments*

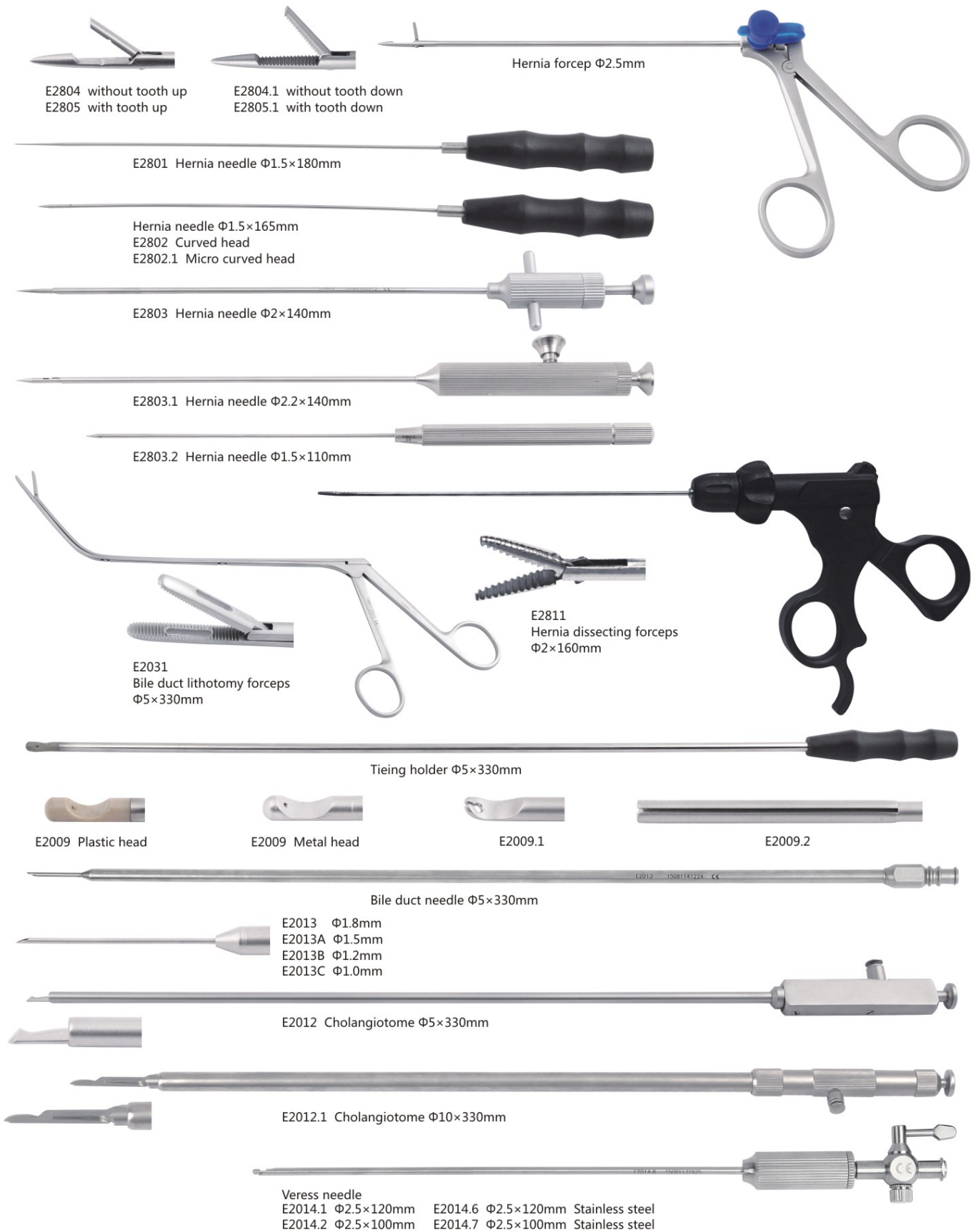

## SURGERY

### Electric coagulation instruments $\Phi 5 \times 330\text{mm}$

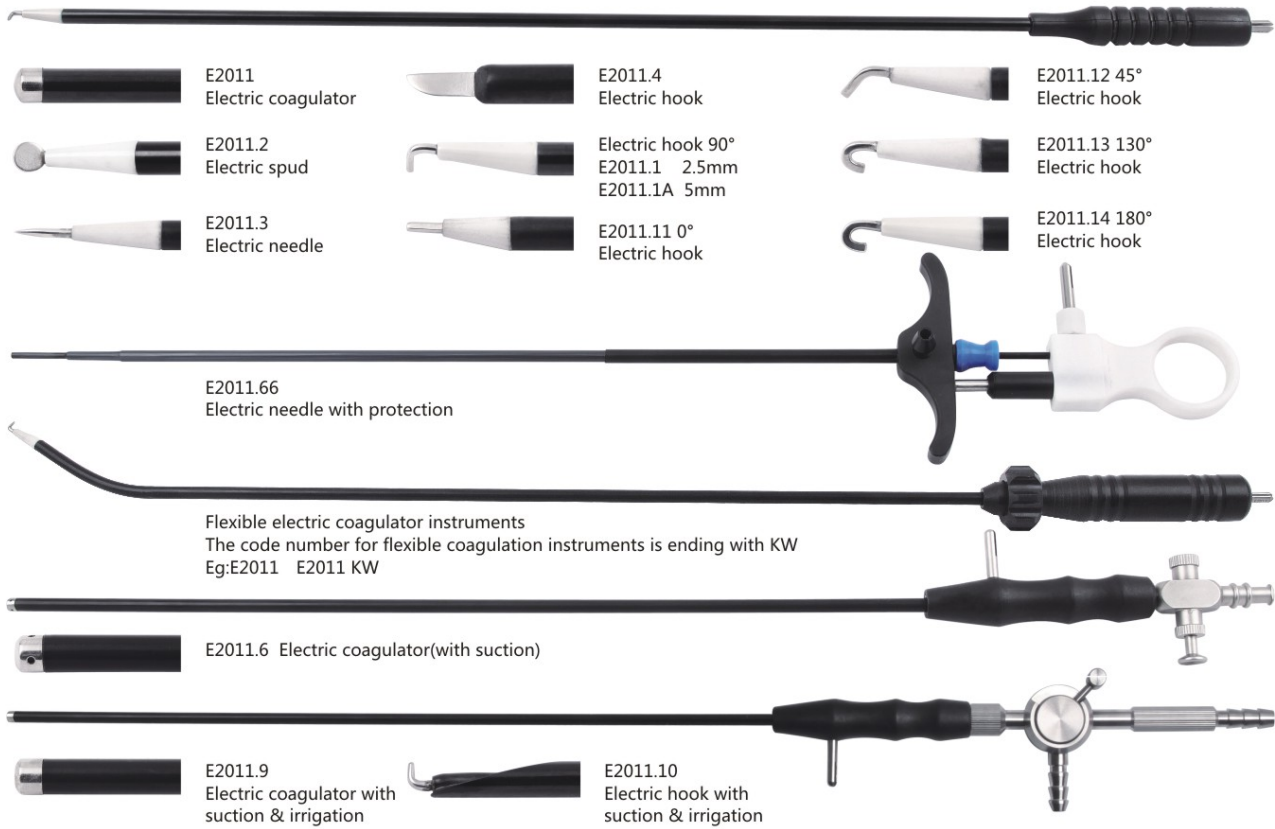

### Suction and irrigation tube

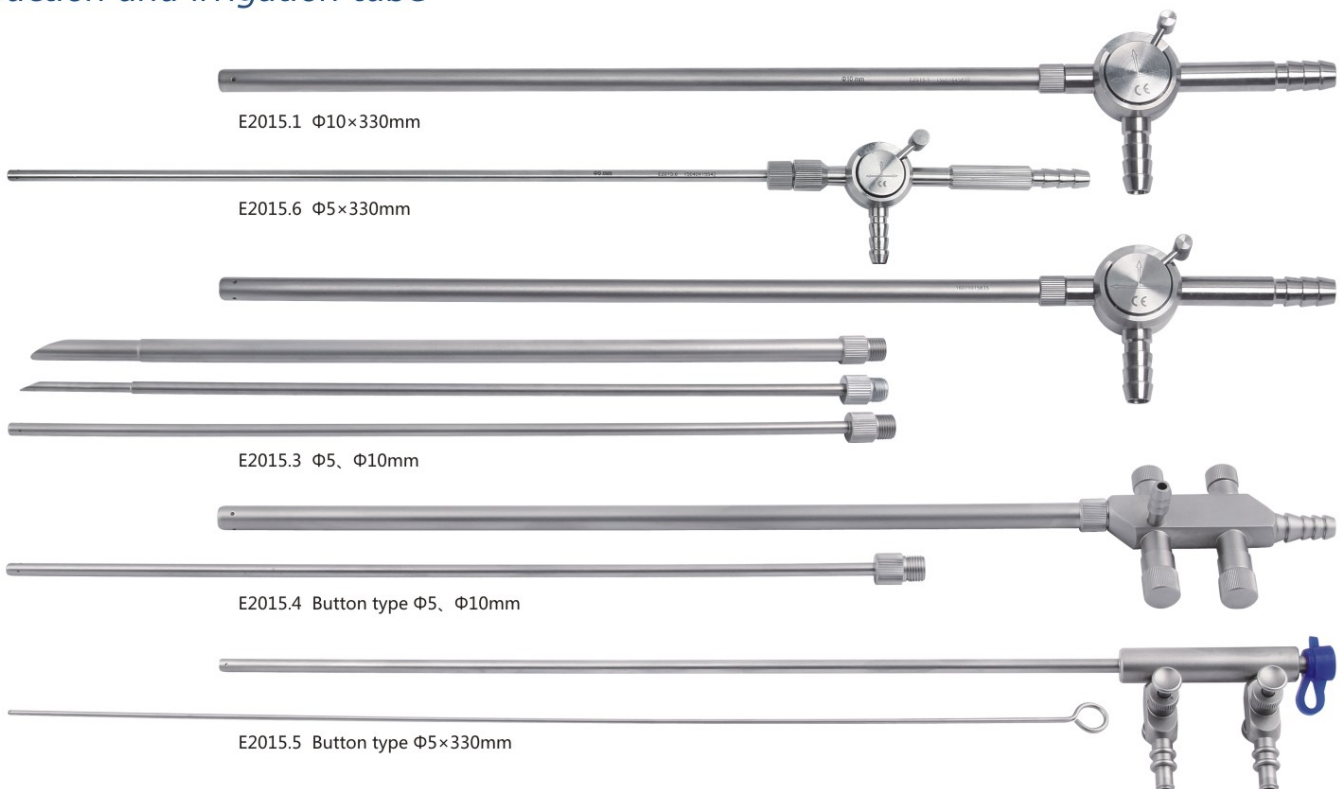

# SURGERY

## Trocar set



With protection  
E2016.3  $\Phi$ 10.5mm  
E2016.4  $\Phi$ 5.5mm  
E2016.7  $\Phi$ 11mm

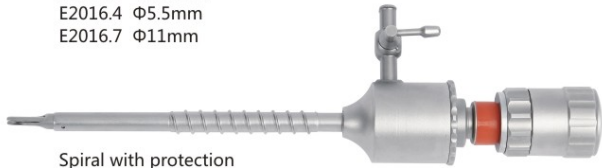

Spiral with protection  
E2016.3A  $\Phi$ 10.5mm  
E2016.4A  $\Phi$ 5.5mm



Cylindric  
E2016.5  $\Phi$ 10.5mm E2016.6  $\Phi$ 5.5mm  
E2016.8  $\Phi$ 11mm E2016.9  $\Phi$ 12mm  
E2016.10  $\Phi$ 6mm



Cylindric, spiral  
E2016.5A  $\Phi$ 10.5mm  
E2016.6A  $\Phi$ 5.5mm

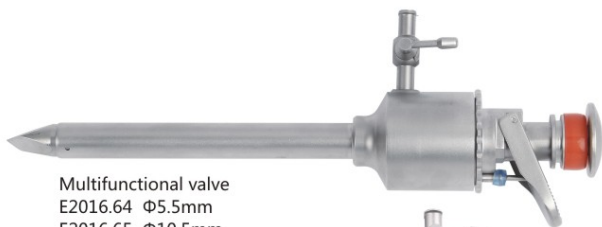

Multifunctional valve  
E2016.64  $\Phi$ 5.5mm  
E2016.65  $\Phi$ 10.5mm  
E2016.66  $\Phi$ 11mm



Multifunctional valve(stainless steel)  
E2016.70  $\Phi$ 11mm



Reducer(stainless steel)  
E2017.1 10mm/5 mm  
E2017.2 5mm/3mm



E6001 Sealing cap 5mm E6002 Sealing cap 10mm



E2017.8 Reducer(10/5 mobile type)



Magnet  
E2016.12  $\Phi$ 5.5mm  
E2016.13  $\Phi$ 10.5mm  
E2016.14  $\Phi$ 11mm  
E2016.15  $\Phi$ 6mm  
E2016.16  $\Phi$ 12mm  
E2016.19  $\Phi$ 5.5mm for Stryker



Spiral magnet  
E2016.17  $\Phi$ 5.5mm  
E2016.18  $\Phi$ 10.5mm  
E2016.24  $\Phi$ 6mm



Magnet, with protection  
E2016.20  $\Phi$ 5.5mm  
E2016.21  $\Phi$ 6mm  
E2016.22  $\Phi$ 10.5mm  
E2016.23  $\Phi$ 11mm

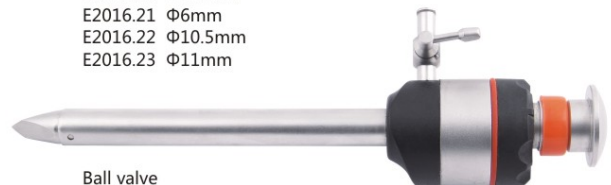

Ball valve  
E2016.41  $\Phi$ 5.5mm  
E2016.42  $\Phi$ 6mm  
E2016.43  $\Phi$ 10.5mm  
E2016.44  $\Phi$ 11mm



Simple crossed sealing cap  
E2016.67  $\Phi$ 6mm  
E2016.68  $\Phi$ 10.5mm



E2017.4 Reducer (Engineering plastic) 10mm/5mm



E2017.5 Reducer (Engineering plastic button) 10mm/5mm



**SURGERY**

*Thyroid instruments*

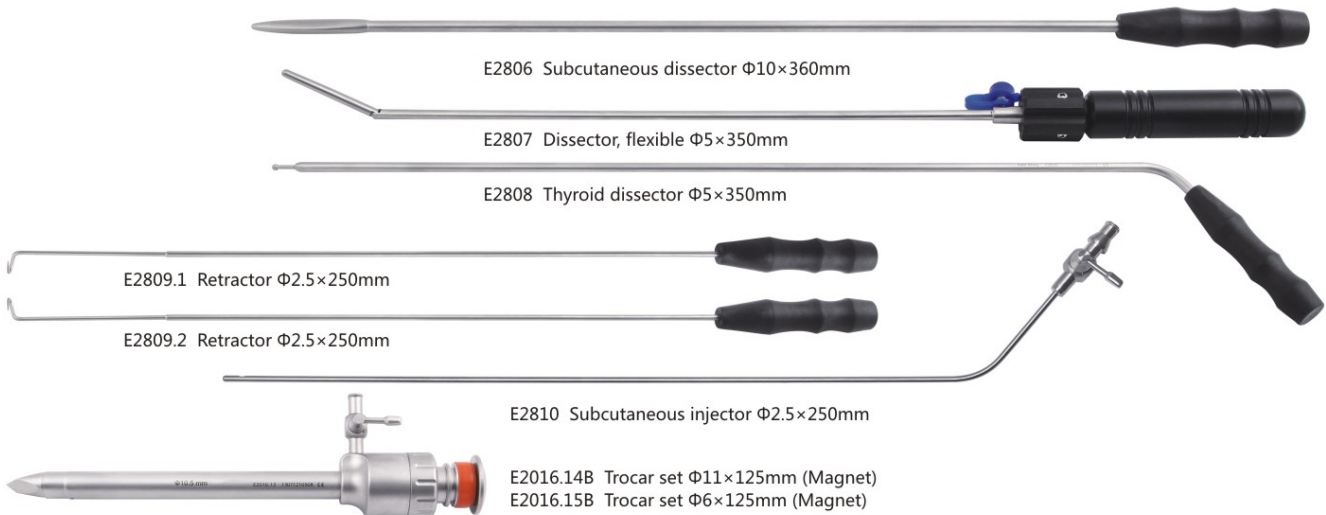

*$\Phi 5 \times 400$ mm Single port umbilical laparoscopy instruments*

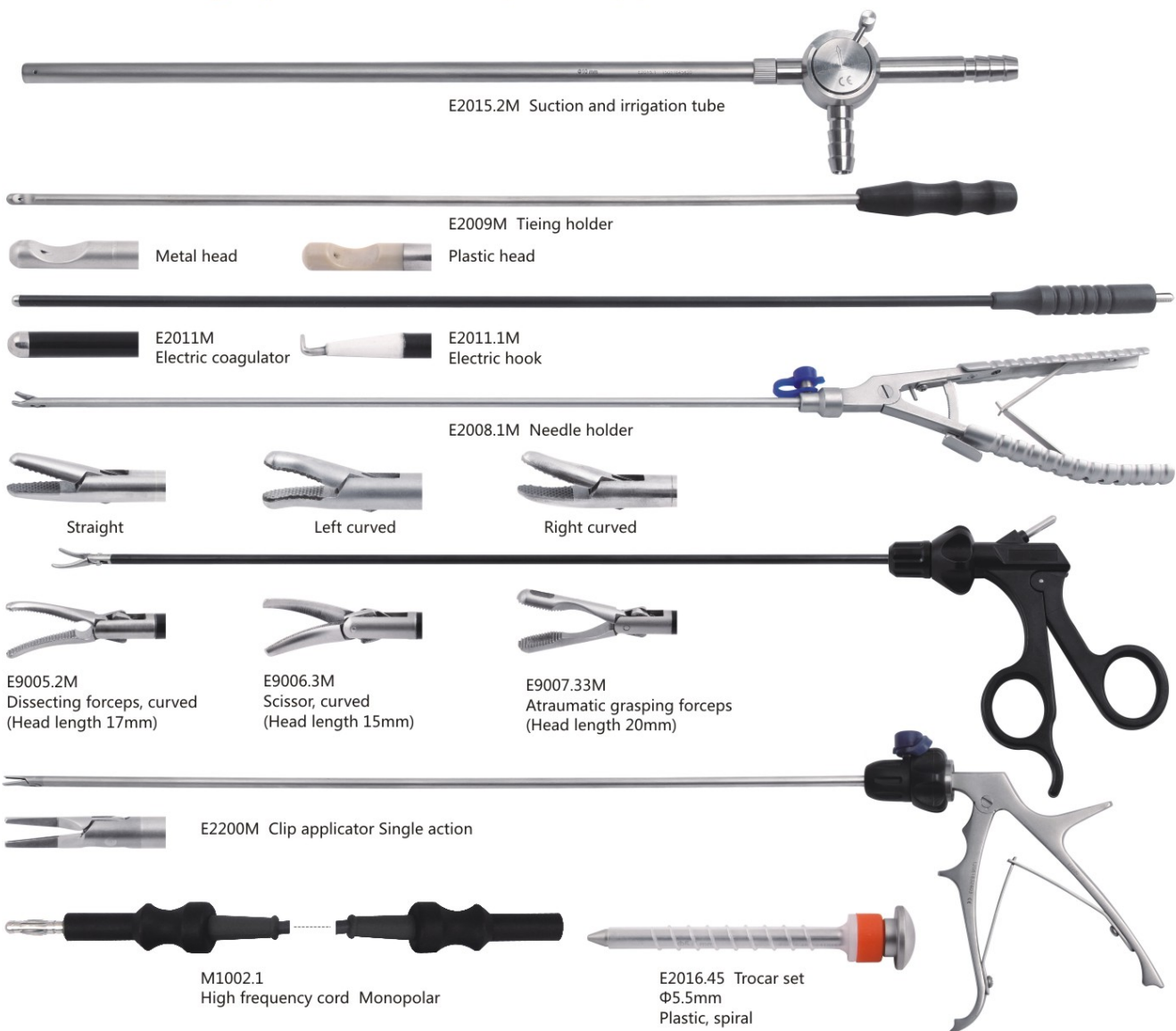

*Single port umbilical laparoscopy instruments(Curved)*

E0005.1 Endoscope 30° Autoclavable Φ5×302mm

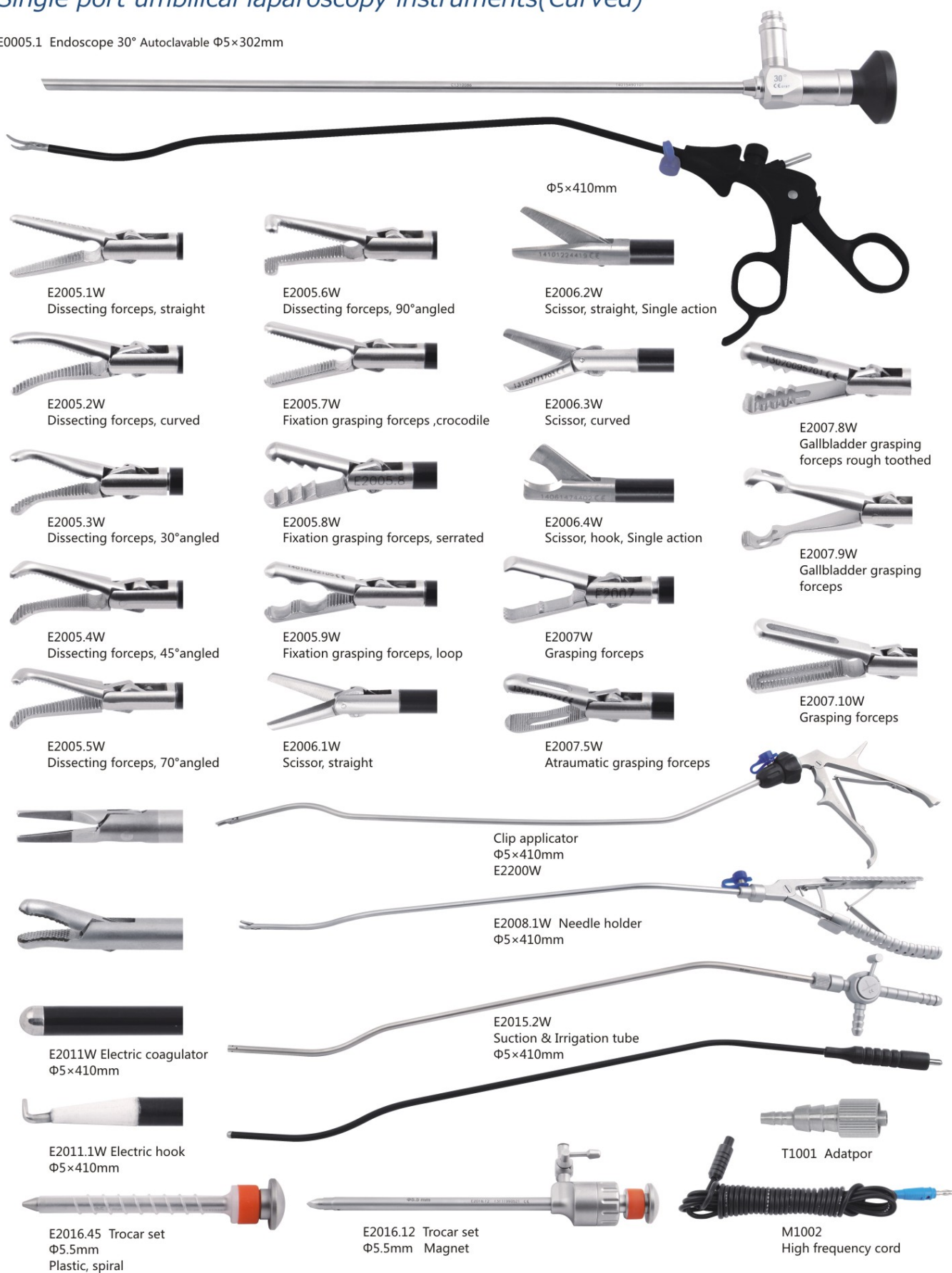

**SURGERY**

*Mini laparoscopy instruments*

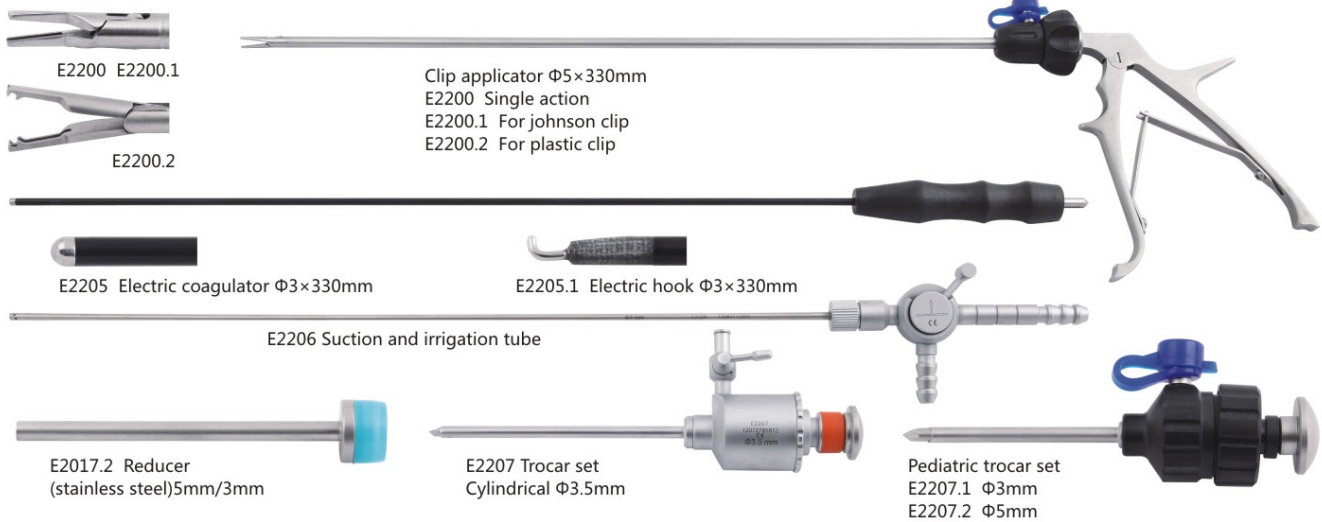

*Small incision instruments*

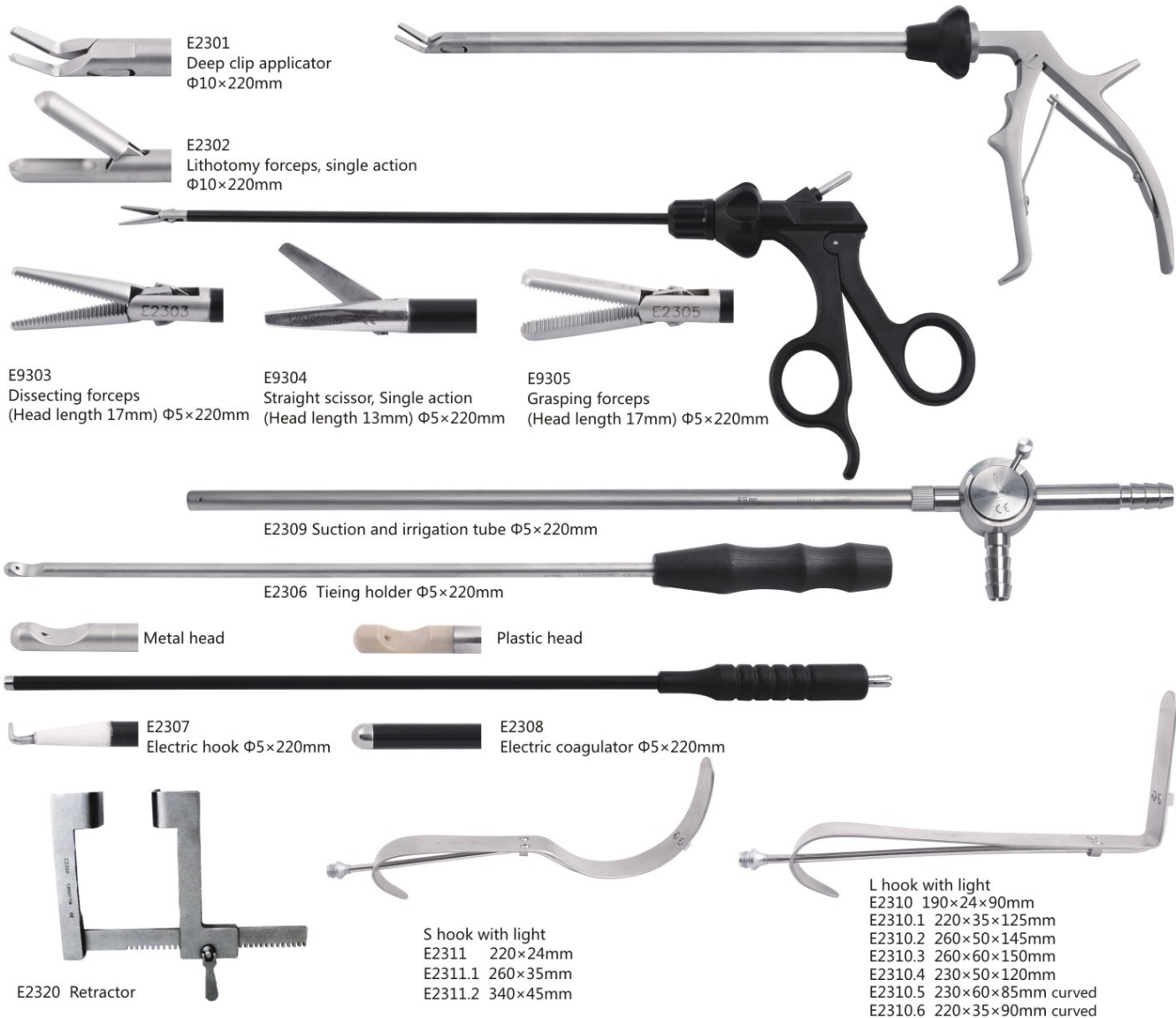



*Thoracoscopy instruments*

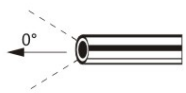

E1001.1 0°  
Φ10×230mm

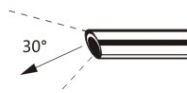

E1002.1 30°  
Φ10×230mm

1. Connecting to FIEGERT light guide cable
- Connecting to OLYMPUS light guide cable
- Connecting to STORZ light guide cable
2. Connecting to WOLF light guide cable
3. Connecting to ACMI, STRYKER light guide cable



Thoracoscope



E2018  
Lung forceps(Head length43mm)  
Φ10×230mm



E7008  
Grasping forceps, greeve teeth, with hole  
(Head length21mm) Φ5×330mm



E7005  
Biopsy forceps spoon straight  
(Head length 13mm) Φ5×330mm



E7009  
Biopsy forceps, with nail  
(Head length 13mm) Φ5×330mm

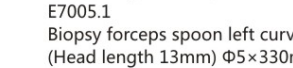

E7005.1  
Biopsy forceps spoon left curved  
(Head length 13mm) Φ5×330mm



E7010  
Biopsy forceps, punch, single action  
(Head length 13mm) Φ5×330mm



E7007  
Grasping forceps, straight, serrated  
(Head length13mm) Φ5×330mm



E7011  
Grasping forceps, no tooth  
(Head length 13mm) Φ5×330mm

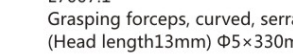

E7007.1  
Grasping forceps, curved, serrated  
(Head length13mm) Φ5×330mm



E2004.3 90°  
Dissecting forceps  
(Head length 33mm) Φ10×230mm



E7014  
Scissor, curved  
(Head length 25mm) Φ10×230mm



E7024 Esophageal forceps  
(Head length 25mm) Φ5×250mm



E7026 Lung tumor forceps  
(Head length 46mm) Φ5×300mm



E7018 Oval forceps  
(Head length 100mm) Φ10×230mm



E7006  
Biopsy forceps ( spoon left curved, single action )  
Φ10×330mm



**SURGERY**

*Thoracoscopy instruments*

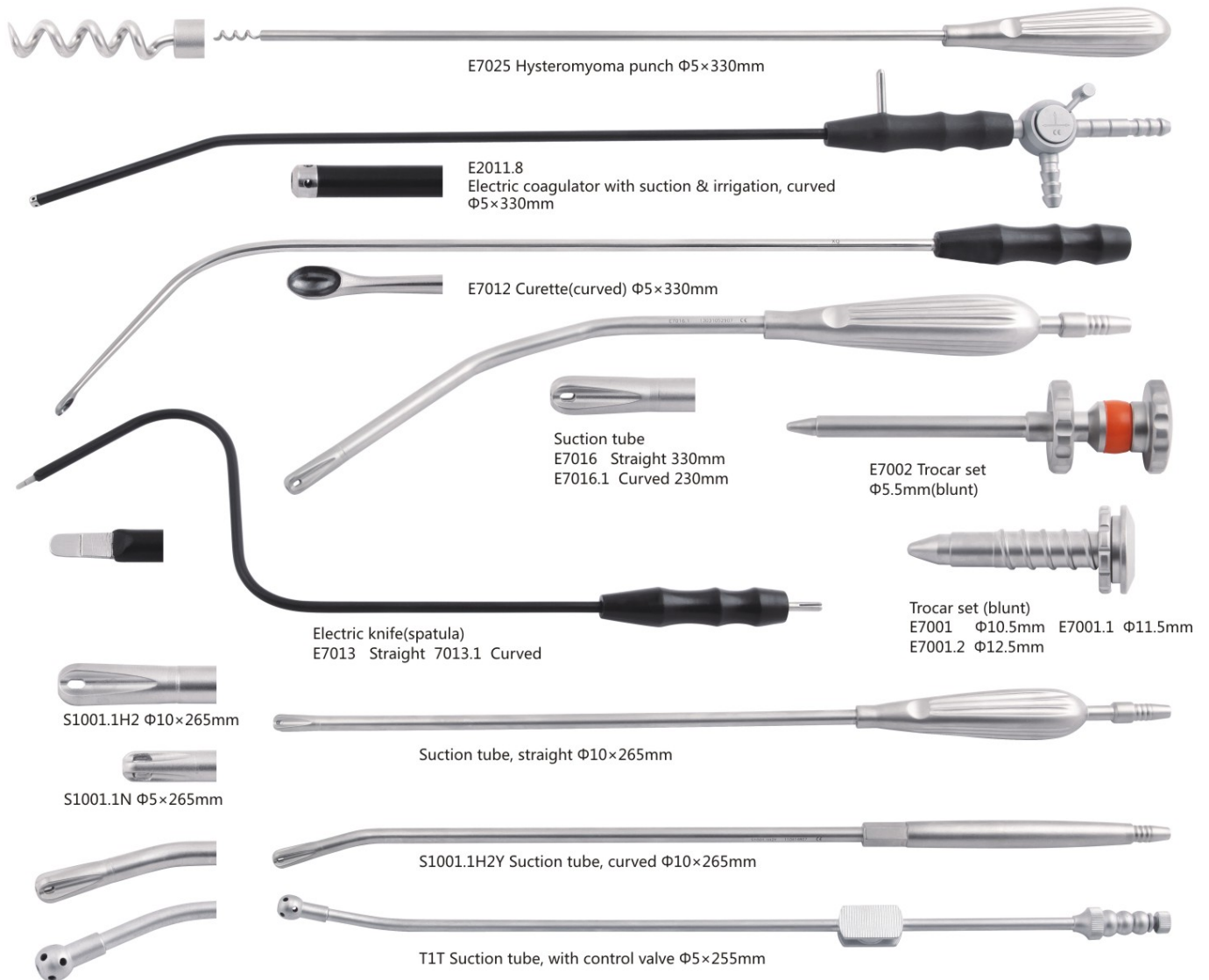
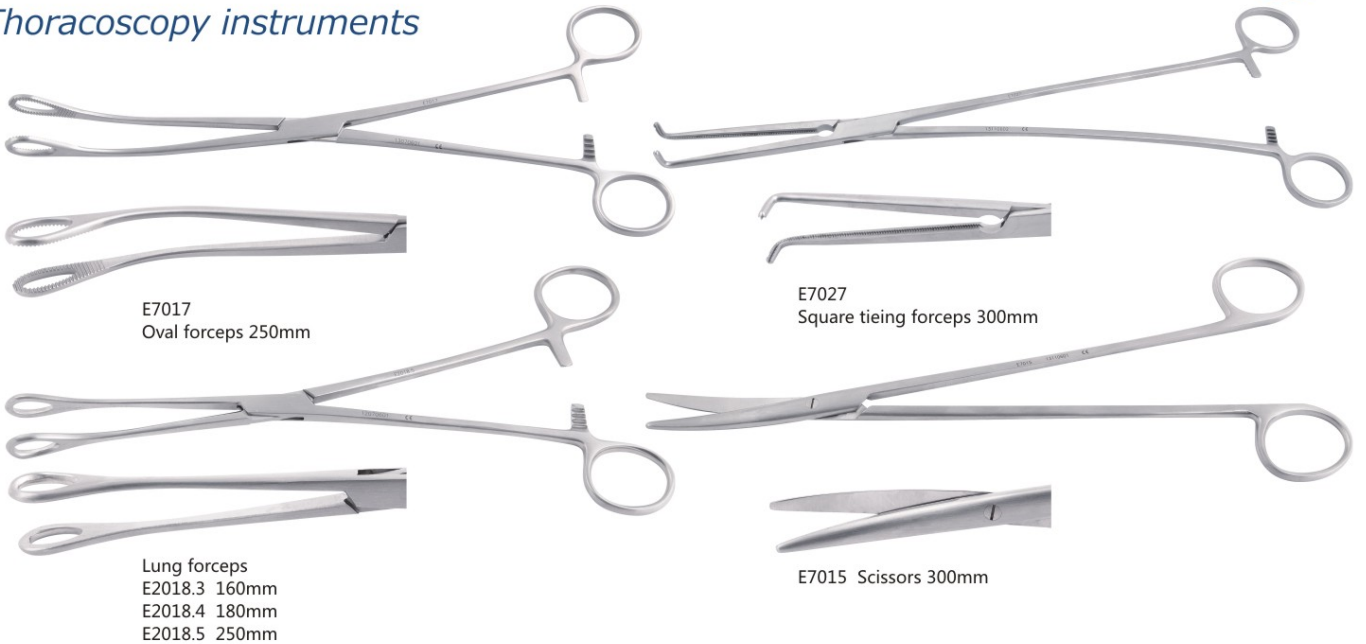

## SURGERY

### Thoracoscopy instruments

#### Double-jointed instruments



Hemostatic forceps  $\Phi 5 \times 330$ mm  
E7028 Curved length 15mm  
E7028.1 Curved length 20mm  
E7028.2 Curved length 25mm  
E7028.3 Straight length 25mm  
E7028.4 Free forceps

Oval forceps  $\Phi 5 \times 330$ mm  
E7029 head wide with teeth 8mm  
E7029.5 head wide with teeth 12mm  
E7029.6 head wide with teeth 10mm  
E7029.7 head wide without teeth 8mm  
E7029.8 head wide without teeth 10mm  
E7029.9 head wide without teeth 12mm



Biopsy forceps ( lymph )  
E7030  $\Phi 5 \times 330$ mm



Scissor  
E7031 straight  
E7031.1 curved



Grasping forceps  
E7032 8mm, straight  
E7032.1 8mm, curved



Needle holder  
E7033 straight  
E7033.1 curved



Suction  
E7034 straight  
E7034.1 curved

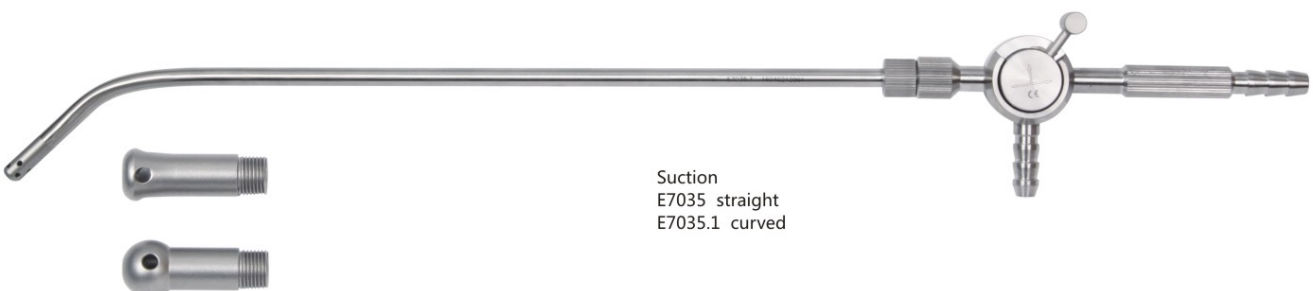

Suction  
E7035 straight  
E7035.1 curved



**SURGERY**

*Thoracoscopy instruments*

Double-jointed instruments

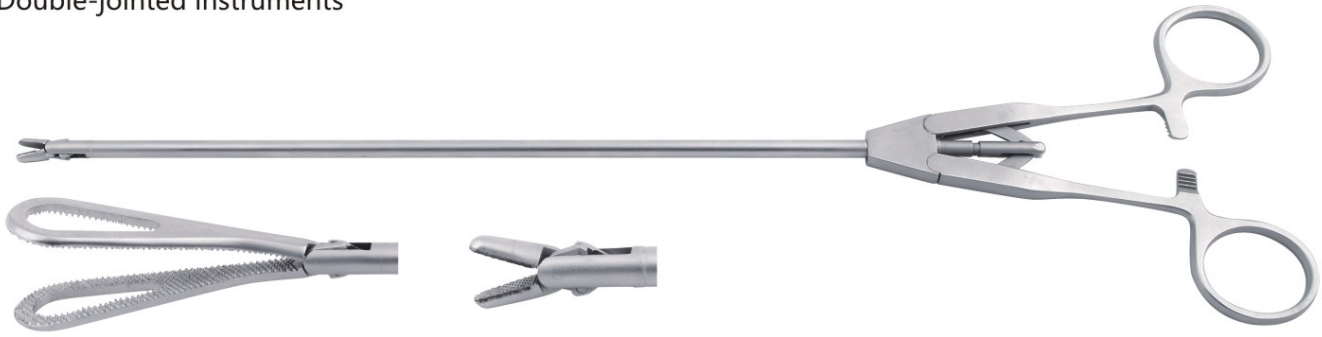

E2018A6G  
Lung forceps  $\Phi 5 \times 300\text{mm}$

E2005.8A  
Needle holder  $\Phi 5 \times 230\text{mm}$



E2005.3G Hemostatic forceps, curved  
 $\Phi 5 \times 250\text{mm}$

E2005.3G2 Hemostatic forceps  
 $\Phi 5 \times 270\text{mm}$



E2005.3G4 Hemostatic forceps  
 $\Phi 5 \times 270\text{mm}$



E2005.5G Hemostatic forceps  
curved,  $90^\circ \Phi 5 \times 230\text{mm}$



E31104.1 Straight scissor  
 $\Phi 5 \times 250\text{mm}$



E31104.2B Scissor, curved  
 $\Phi 5 \times 250\text{mm}$



E2005.11AUC  
Hemostatic forceps, curved



E2005.12K1  
Lymph tweezers, curved  $\Phi 10\text{mm}$

**SURGERY**

*High frequency cord*



M1001  
Monopolar: for FIEGERT resectoscope



M1002.1  
High frequency cord Monopolar

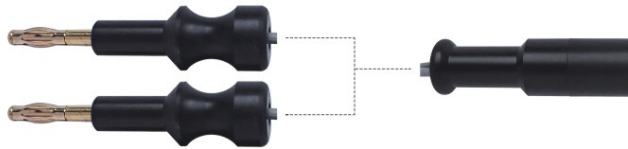

M1003  
Monopolar: for WOLF bipolar forceps

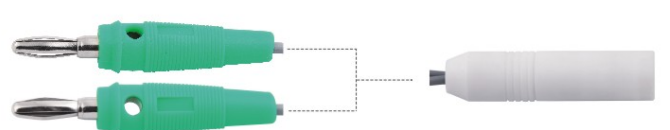

M1004  
Bipolar: for FIEGERT diskoscope and ventriculoscope



M1005  
Monopolar: one end for OLYMPUS HF Generator, the other for FIEGERT instruments



M1005.1  
Monopolar: Transfer connector, for OLYMPUS HF Generator



M1005.2  
Monopolar: one end for OLYMPUS HF Generator, the other for FIEGERT resectoscope

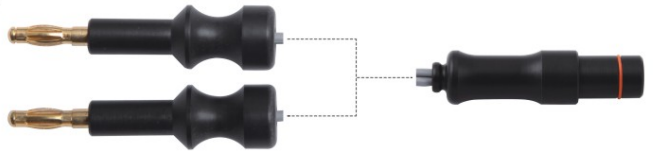

M1006  
Bipolar: for bipolar forceps E2316 series

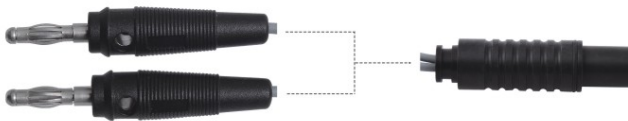

M1007  
Bipolar: one end of FIEGERT Generator, the other for STORZ bipolar forceps



M1008  
Monopolar: one end for OLYMPUS HF Generator, the other for STORZ instruments



M1009  
Monopolar: one end for Hutong HF Generator, the other for FIEGERT instruments



M1009.1  
Monopolar: Transfer connector, for Hutong HF Generator



M1010  
Monopolar: one end for OLYMPUS HF Generator, the other for WOLF instruments



M1013  
Monopolar: for OLYMPUS instruments



M1011  
Monopolar: one end for WOLF HF Generator, the other for WOLF instruments



M1015  
Monopolar: for STORZ resectoscope and FIEGERT DQ-4 resectoscope



M1012  
Monopolar: for STRYKER resectoscope



M1017 Bipolar



M1020.1  
High frequency cord (Bipolar)

**SURGERY**

*ZCX Automatic suction and rinsing apparatus*

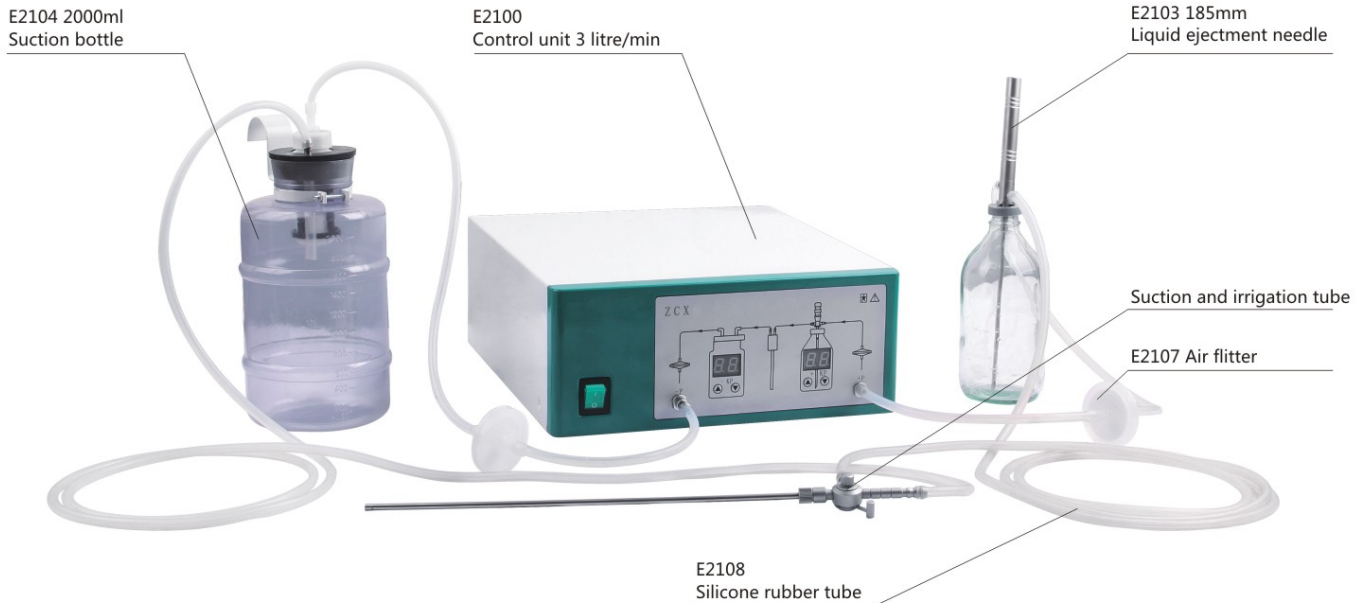

*Golden finger*

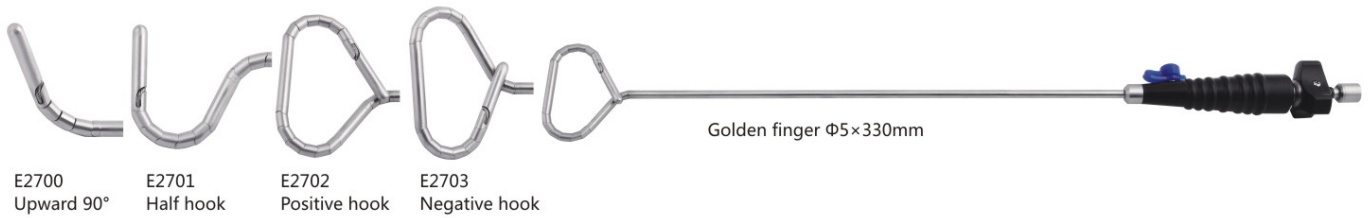

*Ligation forceps*

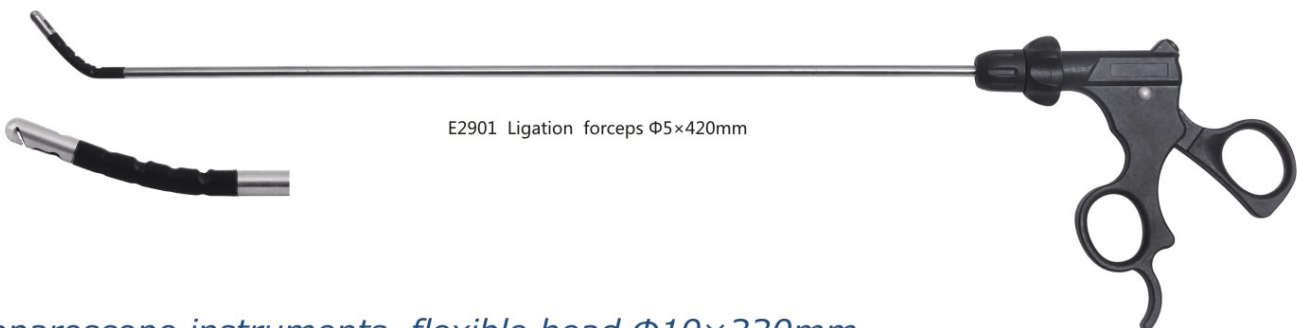

*Laparoscope instruments, flexible head  $\Phi 10 \times 330\text{mm}$*

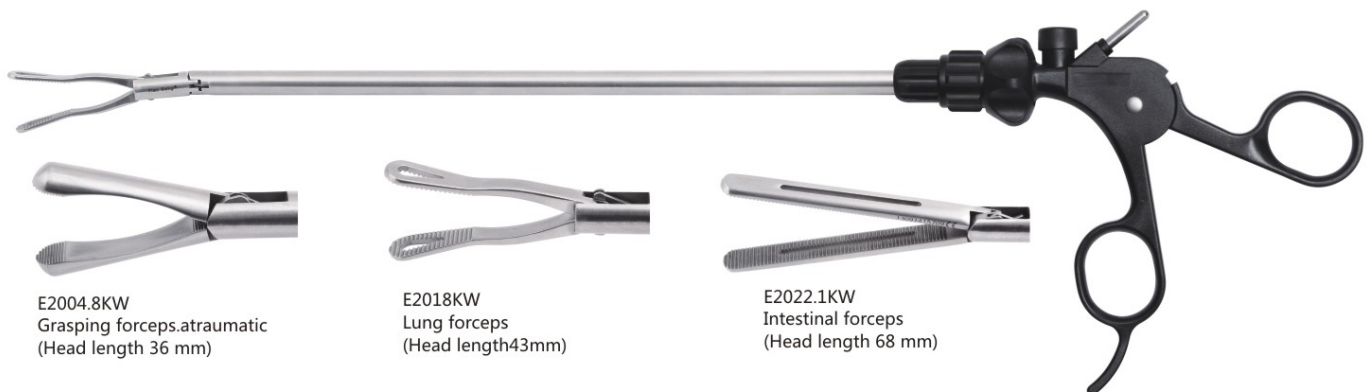



## ANS-ENTEROLOGY

### CJ-1 Sigmoidoscope set



Sigmoidoscope  
H1001  $\Phi 20 \times 300\text{mm}$   
H1002  $\Phi 15 \times 300\text{mm}$   
H1003  $\Phi 20 \times 230\text{mm}$



H0001 Magnifier

### CJ-2 Rectoscopy set

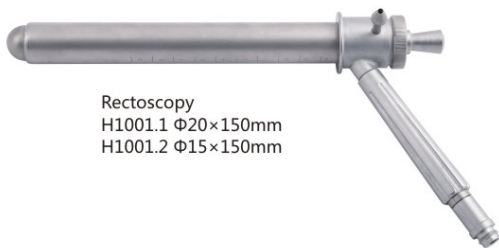

Rectoscopy  
H1001.1  $\Phi 20 \times 150\text{mm}$   
H1001.2  $\Phi 15 \times 150\text{mm}$



H0001 Magnifier

### CJ-3 Sigmoidoscope set

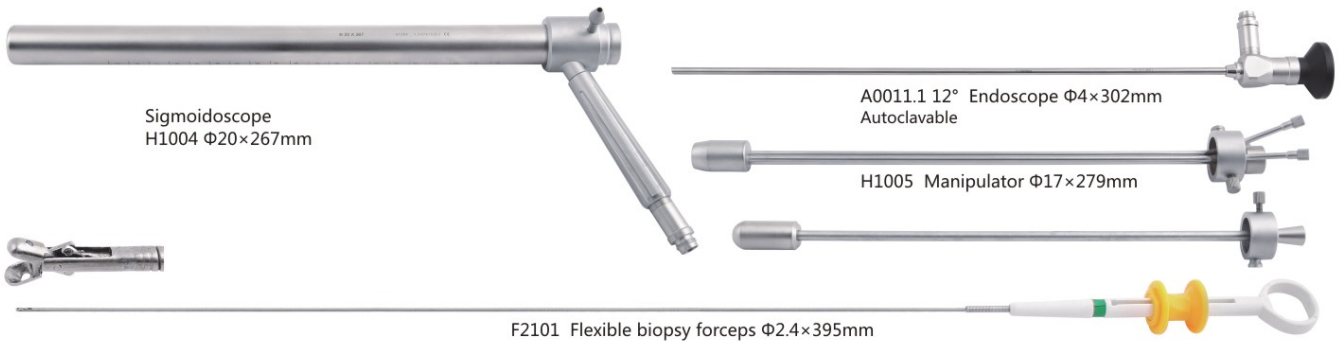

Sigmoidoscope  
H1004  $\Phi 20 \times 267\text{mm}$

A0011.1 12° Endoscope  $\Phi 4 \times 302\text{mm}$   
Autoclavable

H1005 Manipulator  $\Phi 17 \times 279\text{mm}$

F2101 Flexible biopsy forceps  $\Phi 2.4 \times 395\text{mm}$

### CJ-1, CJ-2, CJ-3 Sigmoidoscope & Rectoscopy set interchangeable parts

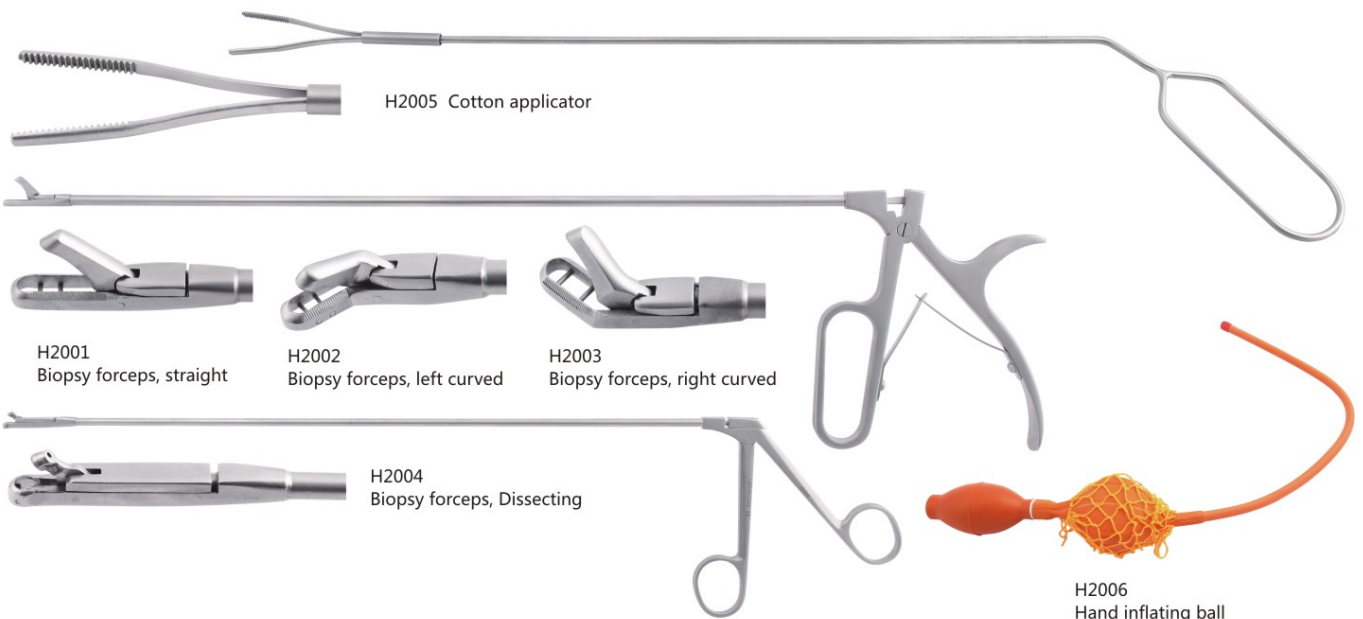

H2005 Cotton applicator

H2001  
Biopsy forceps, straight

H2002  
Biopsy forceps, left curved

H2003  
Biopsy forceps, right curved

H2004  
Biopsy forceps, Dissecting

H2006  
Hand inflating ball